



It's all about learning.

TEQ-C7989M, C7489, C7489M, C6989 Projectors

User's Manual (concise)

Thank you for purchasing this projector. Please read through this manual to ensure proper safety and operation.

WARNING

- Before using this product, be sure to read the entire manual. After reading the manual, store it in a safe place for future reference.
- Heed all the warnings and cautions in the manual or on the product.
- Follow all the instructions in the manual or on the product.

NOTE

In this manual, unless any comments are accompanied, "the manuals" means all the documents provided with this product, and "the product" means this projector and all the accessories came with the projector.

Contents

Introduction	2	Connecting the power supply	10
Entries and graphical symbols explanation	2	Turning on the power	11
Important Safety Instruction	2	Adjusting the projector's elevator feet	12
Regulatory Notices	3	Displaying the picture	13
About Electro-Magnetic Interference	3	Turning off the power	14
About Waste Electrical and Electronic Equipment	3	Replacing the lamp	15
Contents of package	4	Cleaning and replacing the air filter	17
Preparations	5	Replacing the internal clock battery	19
Loading batteries into the remote control	5	Specifications	20
Arrangement	6	Troubleshooting	21
Connecting your devices	8		

INTRODUCTION

Warnings

The following entries and graphical symbols are used for the manuals and the product, for safety purposes. Please know their meanings beforehand, and heed them.

WARNING This entry has a risk of serious personal injury or even death.

CAUTION This entry has a risk of personal injury or physical damage.

NOTICE This entry notices a fear of causing trouble.

Important Safety Instruction

The following are important safety instructions. Be sure to follow them when handling the product. The manufacturer assumes no responsibility for any damage caused by mishandling the product beyond normal usage defined in these manuals.

WARNING

- Never use the product in or after an abnormality (ex. smoke, strange smell, foreign liquid or object lodged inside, malfunction, etc.) If an abnormality should occur, unplug the projector immediately.
- Situate the product away from children and pets.
- Unplug the projector from the power outlet if the projector is not being used for an extended period.
- Do not open or remove any portion of the product, unless the manuals direct it. For internal maintenance, contact Teq.
- Only use the accessories specified or recommended by Teq.
- Do not modify the projector or accessories.
- Do not let any objects or liquids get inside the product.
- Do not wet the product.
- Do not place the projector where any oils, such as cooking or machine oil, are used. Oil may harm the product, resulting in malfunction, or falling from the mounted position.
- Do not apply a shock or pressure to this product.
 - Do not place the product on an unstable place such as an uneven surface.
 - Remove all the attachments, including the power cord and cables, when carrying the projector.
- Do not look into the lens and the openings on the projector, while the lamp is on.
- Do not approach the lamp cover and the exhaust vents while the projection lamp is on. After the lamp goes out, do not touch it until the projector cooled sufficiently.

REGULATORY NOTICES

About Electro-Magnetic Interference

IN CANADA

This Class B digital apparatus complies with Canadian ICES-003.

IN THE US AND OTHER PLACES WHERE THE FCC REGULATIONS ARE APPLICABLE

This device complies with part 15 of the FCC Rules. Operation is subject to the following two conditions: (1) This device may not cause harmful interference, and (2) this device must accept any interference received, including interference that may cause undesired operation.

This equipment has been tested and found to comply with the limits for a Class A digital device, pursuant to Part 15 of the FCC Rules.

These limits are designed to provide reasonable protection against harmful interference in a residential installation. This equipment generates, uses and can radiate radio frequency energy and, if not installed and used in accordance with the instructions, may cause harmful interference to radio communications. However, there is no guarantee that interference will not occur in a particular installation. If this equipment causes harmful interference to radio or television reception, which can be determined by turning the equipment off and on. The user is encouraged to try to correct the interference by one or more of the following measures:

- Reorient or relocate the receiving antenna.
- Increase the separation between the equipment and receiver.
- Connect the equipment to an outlet on a circuit different from the receiver.
- Consult the dealer or an experienced radio/TV technician for help.

Instructions to Users

This equipment complies with the requirements of FCC (Federal Communication Commission) equipment provided that the following conditions are met. Some cables have to be used with the core set. Use the accessory cable or a designated-type cable for the connection. For cables that have a core only at one end, connect the core to the projector.

CAUTION

Unapproved changes or modifications may void the user's authority to operate the equipment.

REGULATORY NOTICES (continued)

About Waste Electrical and Electronic Equipment



The mark is in compliance with the Waste Electrical and Electronic Equipment Directive 2002/96/EC (WEEE). The mark indicates that you must dispose the equipment, including any spent or discarded batteries or accumulators, as unsorted municipal waste. Use the return and collection systems available. If the batteries or accumulators included with this equipment display the chemical symbol Hg, Cd, or Pb, it means the battery has a heavy metal content of more than 0.0005% Mercury, or more than, 0.002% Cadmium, or more than 0.004% Lead.

CONTENTS OF PACKAGE

Your projector should come with the items shown below. Make sure all the items are included. If any items are missing, contact Teq.

- (1) Remote control with the two AA batteries
- (2) Power cord
- (3) Computer cable
- (4) Lens cover
- (5) Security label
- (6) Application CD

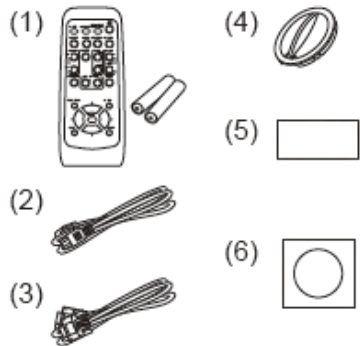

NOTE

Keep all original packing materials for future reshipment. Be sure to use the original packing materials when moving the projector. Use special caution for the lens.

PREPARATIONS

Loading batteries into the remote control

Please insert the batteries into the remote control before use. If the remote control starts to malfunction, try to replace the batteries. If you will not use the remote control for an extended period, remove the batteries from the remote control and store them in a safe place.

1. Hold the hook part of the battery cover and remove it.
2. Align and insert the two AA batteries according to their plus and minus terminals, as indicated in the remote control.
3. Replace the battery cover in the direction of the arrow and snap it back into place.

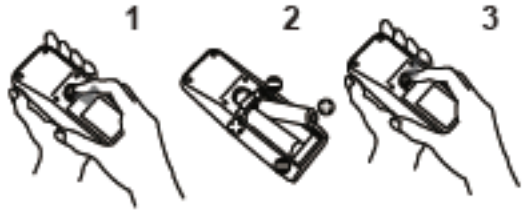

WARNING

Always handle the batteries with care and use them only as directed. Improper use may result in battery explosion, cracking or leakage, which may result in fire, injury and/or pollution of the surrounding environment.

- When replacing the batteries, replace both of the batteries with new batteries of the same type. Do not use a new battery with a used battery.
- Be sure to only use the batteries specified. Do not use batteries of different types at the same time. Do not mix a new battery with used one.
- Make sure the plus and minus terminals are correctly aligned when loading a battery.
- Keep a battery away from children and pets.
- Do not recharge, short circuit, solder or disassemble a battery.
- Do not place a battery in a fire or water. Keep batteries in a dark, cool and dry place.
- If you observe battery leakage, wipe out the leakage and then replace a battery. If the leakage adheres to your body or clothes, rinse well with water immediately.
- Obey the local laws on disposing the battery.

ARRANGEMENT

Refer to the illustrations and tables below to determine screen size and projection distance. The values shown in the table are calculated for a full size screen: 1024 x 768

- Ⓐ Screen size (diagonal)
- Ⓑ Projection distance ($\pm 10\%$)
- Ⓒ¹, Ⓒ² Screen height ($\pm 10\%$)

On a horizontal surface

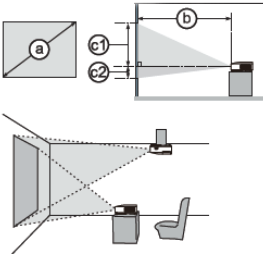

Suspended from the ceiling

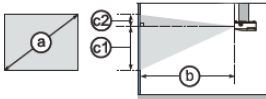

- Keep a space of 30 cm or more between the sides of the projector and other objects such as walls. Do not place or attach anything that would block the lens or vent holes.
- In the case of a specialty installation such as ceiling mount, the specified mounting accessories (📖 20) and service may be required. Before installing the projector, consult Teq about your installation.

16:9 screen							
Ⓑ Projection distance				Ⓒ ¹ Screen height		Ⓒ ² Screen height	
min.		max.					
m	inch	m	inch	cm	inch	cm	inch
1.0	38	1.1	45	39	15	-1	0
1.3	51	1.5	60	51	20	-2	-1
1.6	64	1.9	76	64	25	-2	-1
1.9	77	2.3	91	77	30	-2	-1
2.3	90	2.7	106	90	35	-3	-1
2.6	103	3.1	122	103	41	-3	-1
2.9	116	3.5	137	116	46	-4	-1
3.3	129	3.9	153	129	51	-4	-2
3.9	155	4.7	183	154	61	-5	-2
4.9	194	5.8	229	193	76	-6	-2
6.6	259	7.8	306	257	101	-8	-3
8.2	324	9.7	383	322	127	-10	-4
9.9	389	11.7	460	386	152	-12	-5

4:3 screen									
Ⓐ Screen size (diagonal)		Ⓑ Projection distance				Ⓒ ¹ Screen height		Ⓒ ² Screen height	
		min.		max.					
type (inch)	m	m	inch	m	inch	cm	inch	cm	inch
30	0.8	0.9	34	1.0	41	41	16	5	2
40	1.0	1.2	46	1.4	55	55	22	6	2
50	1.3	1.5	58	1.8	69	69	27	8	3
60	1.5	1.8	70	2.1	83	82	32	9	4
70	1.8	2.1	82	2.5	97	96	38	11	4
80	2.0	2.4	94	2.8	112	110	43	12	5
90	2.3	2.7	106	3.2	126	123	49	14	5
100	2.5	3.0	118	3.6	140	137	54	15	6
120	3.0	3.6	142	4.3	168	165	65	18	7
150	3.8	4.5	178	5.3	211	206	81	23	9
200	5.1	6.0	237	7.1	281	274	108	30	12
250	6.4	7.5	297	8.9	352	343	135	38	15
300	7.6	9.1	357	10.7	422	411	162	46	18

ARRANGEMENT (continued)

WARNING

- Install the projector in a stable horizontal position.
- Place the projector in a cool place, and make sure there is sufficient ventilation.
- Do not place the projector anywhere where it may get wet.
- Only use the specified mounting accessories, and leave installing and removing the projector with Teq.
- Read and keep the user's manual.

CAUTION

- Avoid placing the projector in a smoky, humid or dusty place.
- Prevent light from directly hitting the projector's remote sensor.

CONNECTING YOUR DEVICES

Be sure to read the device manuals before connecting them to the projector. Make sure all the devices are suitable to be connected with this product, and prepare the cables to connect. Please refer to the following illustrations to connect the cables:

- When **AUTO** is selected for the **COMPUTER IN1** or **COMPUTER IN2** port in **COMPUTER IN** of the **INPUT** menu, that port will accept component video signals.
- To use the projector's network functions, connect the **LAN** port to the computer's LAN port, or to an access point that is connected to the computer with wireless LAN, using a LAN cable.

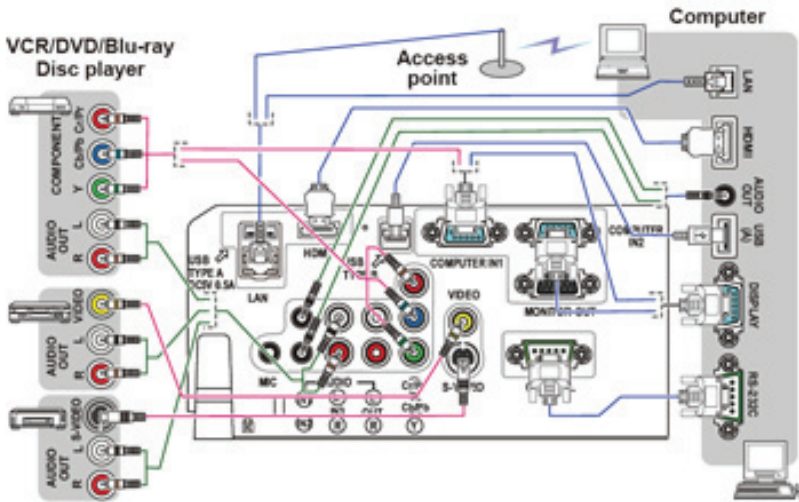

- If you insert a USB storage device, such as a USB memory drive, into the **USB TYPE A** port and select the port as the input source, you can view images stored in the device.
- You can connect a dynamic microphone to the **MIC** port with a 3.5 mm mini-plug. In this case, the built-in speaker will output the sound from the microphone, even while the sound from the projector is output.

CONNECTING YOUR DEVICES (continued)

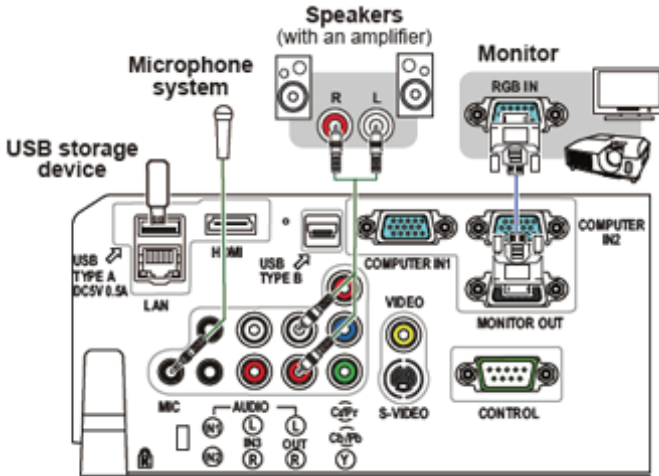

WARNING

- Only use the appropriate accessories. Otherwise, it may cause a fire or damage to the device and the projector.
 - Only use the accessories specified or recommended by the projector's manufacturer. Consult Teq when the required accessory did not come with the product or the accessory is damaged. It may be regulated under some standard.
 - For a cable with a core at only one end, connect the end with the core to the projector. That may be required by EMI regulations.
 - Do not disassemble or modify the projector or the accessories.
 - Do not use a damaged accessory. Be careful not to damage the accessories. Route a cable so that it is neither stepped on nor pinched out.

CAUTION

- Do not turn on or off the projector while connected to a device in operation, unless it is directed in the manual of the device.
- Be careful not to insert a connector incorrectly.
- Before connecting the projector to a network, be sure to obtain the consent of the administrator of the network.
- Do not connect the **LAN** port to any network that might have the excessive voltage.
- Before removing the USB storage device from the port of the projector, be sure to use the REMOVE USB function on the thumbnail screen to secure your data.

NOTE

- If a loud feedback noise is produced from the speaker, move the microphone away from the speaker. This projector does not support plug-in power for the microphone.

CONNECTING POWER SUPPLY

1. Put the connector of the power cord into the **AC IN** (AC inlet) of the projector.
2. Firmly plug the power cord's plug into the outlet. After a few seconds, the **POWER** indicator will light steady orange.

Please remember that when the DIRECT POWER ON function is activated, the connection of the power supply will turn on the projector.

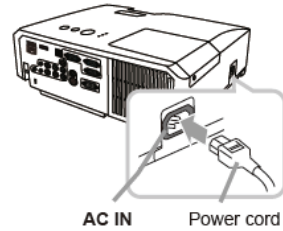

WARNING

- Please use extra caution when connecting the power cord, as incorrect or faulty connections may result in fire and/or electrical shock.
- Only use the power cord that came with the projector. If it is damaged, consult Teq to get a new one.
- Only plug the power cord into an outlet that matches the voltage of the power cord. The power outlet should be close to the projector and easily accessible. Remove the power cord for complete separation.
- Never modify the power cord.

TURNING ON THE POWER

1. Make sure the power cord is firmly and correctly connected to the projector and the outlet.
2. Make sure the **POWER** indicator is steady orange. Then remove the lens cover.
3. Press the **STANDBY/ON** button on the projector or the remote control.

The projection lamp will light up and the **POWER** indicator will begin blinking in green. When the power is completely on, the indicator will stop blinking and light in steady green.

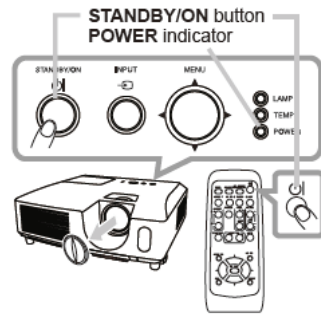

WARNING

- A strong light will emit when the projector's power is on. Do not look into the lens of the projector or look inside of the projector through any of the projector's openings.

NOTE

- Please power on the projector prior to the connected devices.
- The projector has the DIRECT POWER ON function, which can automatically turn on the projector.

ADJUSTING THE PROJECTOR'S ELEVATOR

If the projector is placed on an uneven surface, use the elevator feet to place the projector horizontally.

The feet can also tilt the projector to project at a suitable angle to the screen by elevating the front side within 14 degrees. This projector has 2 elevator feet and 2 elevator buttons. An elevator foot can be adjusted by pushing the elevator button on the same side.

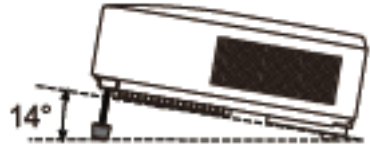

1. Hold the projector, and push the elevator buttons to loosen the feet.
2. Position the front side of the projector to the desired height.
3. Release the elevator buttons to lock the elevator feet.
4. After making sure the elevator feet are locked, put the projector down gently.
5. If necessary, the elevator feet can be manually twisted to make more precise adjustments. Hold the projector when twisting the feet.

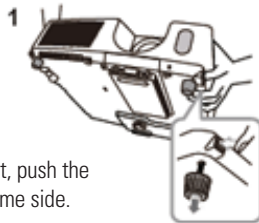

To loosen an elevator foot, push the elevator button on the same side.



Twist the foot, to finely adjust.

CAUTION

- Do not handle the elevator buttons without holding the projector, since the projector may drop down.
- Do not tilt the projector, other than elevating its front within 14 degrees using the adjuster feet. A tilt of the projector exceeding the restriction may cause a malfunction, or shorten the lifetime of the projector.

DISPLAYING THE PICTURE

1. Activate your signal source. Turn on the signal source, and make it send the signal to the projector.
2. Use the **VOLUME + / VOLUME -** buttons to adjust the volume. To silence the projector, press the **MUTE** button on the remote control.
3. Press the **INPUT** button on the projector. Each time you press the button, the projector will switch its input port. You can also use the remote control to select an input signal. Press the **VIDEO** button to select an input signal from the **HDMI, COMPONENT (Y, Cb/Pb, Cr/Pr), S-VIDEO** or **VIDEO** port, or the **COMPUTER** button to select an input signal from the **COMPUTER IN1, COMPUTER IN2, LAN, USB TYPE A** or **USB TYPE B** port.
4. Press the **ASPECT** button on the remote control. Each time you press the button, the projector will switch the mode for aspect ratio.
5. Use the zoom ring to adjust the screen size.
6. Use the focus ring to focus the picture.

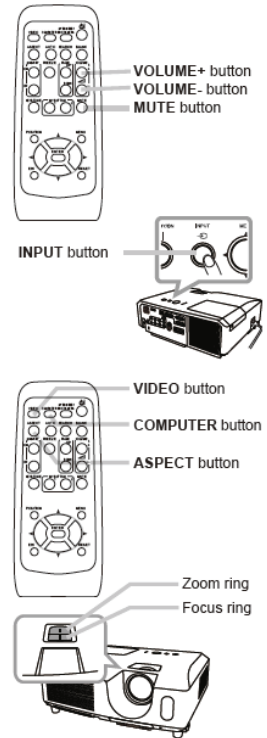

CAUTION

- If you wish to have a blank screen while the projector's lamp is on, use one of methods below:
 - Use the supplied lens cover.
 - Use the BLANK function.
- Taking any other action may cause the damage on the projector.

NOTE

- The ASPECT button will not work without the proper signal.

TURNING OFF THE POWER

1. Press the **STANDBY/ON** button on the projector or the remote control. The message "Power off?" will appear on the screen for about 5 seconds.
2. Press the **STANDBY/ON** button again when the message appears. The projector lamp will go off, and the **POWER** indicator will begin blinking in orange. Then the **POWER** indicator will stop blinking and light in steady orange when the lamp cooling is complete.
3. Attach the lens cover, after the **POWER** indicator turns in steady orange.

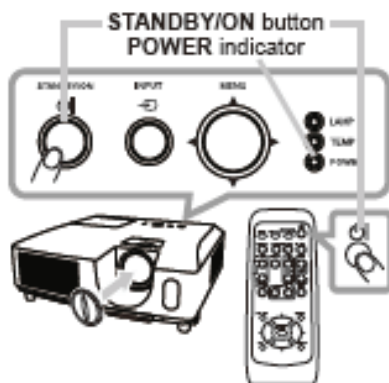

Do not turn on the projector for about 10 minutes or more after turning it off. Turning the projector on again too soon may shorten the lifetime of some consumable parts.

WARNING

- Do not touch around the lamp cover or the exhaust vents during use or just after use, since it is too hot.
- Remove the power cord for complete separation. The power outlet should be close to the projector and easily accessible.

NOTE

- Please power off all connected devices before powering off the projector.
- The AUTO POWER OFF function can make the projector turn off automatically.

REPLACING THE LAMP

A lamp has a finite product life. Using the lamp for long periods of time may cause the pictures to darken or compromise the color tone. Note that each lamp has a different lifetime, and some may burst or burn out soon after you start using them. Preparation of a new lamp and early replacement are recommended. To prepare a new lamp, make contact Teq with the lamp type number:

Type number : DT01021

1. Turn off the projector, and unplug the power cord. Allow the projector to cool for at least 45 minutes.
2. Prepare a new lamp. If the projector is mounted on a wall or ceiling or if the lamp has broken, ask Teq to replace the lamp.

If you choose to replace the lamp yourself, consult the following procedure.

3. Loosen the screw (marked by arrow) of the lamp cover and then slide and lift the lamp cover to the side to remove it.
4. Loosen the 3 screws (marked by arrow) of the lamp, and slowly pick up the lamp by the handles. Never loosen any other screws.
5. Insert the new lamp, and firmly retighten the 3 screws of the lamp that were loosened in the previous process to lock it in place.
6. While putting the interlocking parts of the lamp cover and the projector together, slide the lamp cover back in place. Then firmly fasten the screw of the lamp cover.
7. Turn on the projector and reset the lamp time using the LAMP TIME item in the OPTION menu.

(1) Press the **MENU** button to display a menu.

(2) Point at the ADVANCED MENU in the menu using the ▼/▲ button, then press the ► button.

(3) Point at the OPTION in the left column of the menu using the ▼/▲ button, then press the ► button.

(4) Point at the LAMP TIME using the ▼/▲ button, then press the ► button. A dialog will appear.

(5) Press the ► button to select "OK" on the dialog. This will reset the lamp time.

CAUTION

- Do not touch any inner space of the projector, when the lamp is out.

NOTE

- Only reset the lamp time when you have replaced the lamp.

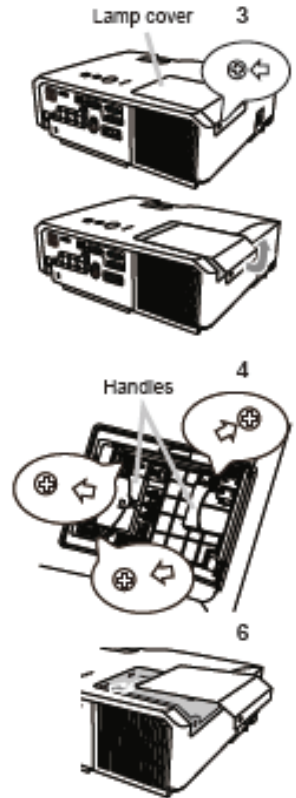

REPLACING THE LAMP (continued)

HIGH VOLTAGE HIGH TEMPERATURE HIGH PRESSURE

WARNING

- The projector uses a high-pressure mercury glass lamp. The lamp can break with a loud bang, or burn out if jolted or scratched, handled while hot, or worn over time. Note that each lamp has a different lifetime, and some may burst or burn out soon after use. If the bulb bursts, it is possible for shards of glass to fly into the lamp housing, and for gas containing mercury and dust containing fine particles of glass to escape from the projector's vent holes.
- **About disposal of a lamp:** This product contains a mercury lamp; do not put it in a trash. Dispose of it in accordance with environmental laws.
- For lamp recycling, go to www.lamprecycle.org (in the US).
- For product disposal, consult your local government agency or www.eiae.org (in the US) or www.epsc.ca (in Canada). For more information, ask Teq.



Disconnect
the plug
from the
power
outlet

- If the lamp should break (it will make a loud bang when it does), unplug the power cord from the outlet, and make sure to request a replacement lamp from Teq. Note that shards of glass could damage the projector's internals, or cause injury during handling, so please do not try to clean the projector or replace the lamp yourself.
- If the lamp should break (it will make a loud bang when it does), ventilate the room well, and make sure not to inhale the gas or fine particles that come out from the projector's vent holes. Do not get particles into your eyes or mouth.
- Before replacing the lamp, turn off the projector and unplug the power cord, then wait at least 45 minutes for the lamp to cool sufficiently. Handling the lamp while hot may cause burns, as well as damage to the lamp.



- Never unscrew anything except the appointed (marked by an arrow) screws.
- Do not open the lamp cover while the projector is mounted on a wall or ceiling. This is dangerous, since if the lamp's bulb has broken, the shards will fall out when the cover is opened. Working in high places is dangerous, so ask Teq to have the lamp replaced, even if the bulb is not broken.
- Do not use the projector with the lamp cover removed. At the lamp replacing, make sure the screws are screwed in firmly. Loose screws may result in damage or injury.



- Only use the lamp of the specified type. Use of a lamp that does not meet the lamp specifications for this model may cause a fire, damage, or shorten the life of this product.
- If the lamp breaks soon after the first time it is used, it is possible there are electrical problems. If this happens, consult Teq.
- Handle with care: jolting or scratching may cause the lamp bulb to burst during use.
- Using the lamp for long periods of time, may cause it to darken, burn out, or burst. When the pictures appear dark or when the color tone is poor, please replace the lamp as soon as possible. Do not use old (used) lamps; this is a cause of breakage.

CLEANING AND REPLACING THE AIR FILTER

Please check and clean the air filter periodically. When the indicators or a message prompts you to clean the air filter, comply with it as soon as possible. If the filters are damaged or heavily soiled, replace them with the new ones. To prepare the new filters, contact Teq with the following type number:

Type number : MU06481 (Filter set)

When you replace the lamp, please replace the air filter. An air filter of specified type will come together with a replacement lamp for this projector.

1. Turn off the projector, and unplug the power cord. Allow the projector to sufficiently cool down.
2. Use a vacuum cleaner on and around the filter cover.
3. While supporting the projector with one hand, use your other hand to pull the filter cover forward in the direction of the arrow.
4. Use a vacuum cleaner for the filter vent of the projector and the outer side of the filter unit.
5. Take out filters while holding the filter cover.
6. Use a vacuum cleaner on both sides of the filters. When vacuuming up the fine meshed filter, hold it so it will not be sucked in. If the filters are damaged or heavily soiled, replace them with the new ones.
7. Put the filters back into the filter cover. Put the coarse meshed filter into a filter cover first. Then put the fine meshed filter on the coarse meshed one, turning its stitched side up.
8. Put the filter unit back into the projector.
9. Turn on the projector and reset the filter time using the FILTER TIME item in the EASY MENU.

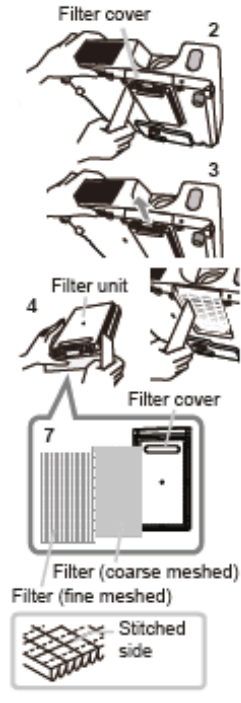

(1) Press the **MENU** button to display a menu.

(2) Point at the FILTER TIME using the ▼/▲ button, then press the ► button. A dialog will appear.

(3) Press the ► button to select "OK" on the dialog. This will reset the filter time.

CLEANING AND REPLACING THE AIR FILTER (continued)

WARNING

- Before taking care of the air filter, make sure the power cable is unplugged. Then, allow the projector to cool sufficiently.
- Only use the air filter of the specified type. Do not use the projector without the air filter or the filter cover. This may result in a fire or a malfunction.
- Clean the air filter periodically. If the air filter becomes clogged, internal temperatures will rise and may cause a fire, burn or malfunction.

NOTE

- Only reset the filter time when you have cleaned or replaced the air filter.
- The projector may display the message such as the “CHECK THE AIR FLOW” or turn off the projector, to prevent the internal heat level rising.

REPLACING THE INTERNAL CLOCK BATTERY

This projector has an internal clock that uses a battery. When the clock of the network function does not work correctly, please try replacing the battery.

1. Turn off the projector, and unplug the power cord. Allow the projector to cool sufficiently.
2. After making sure the projector has cooled adequately, slowly turn over the projector so that the bottom is facing.
3. Turn the battery cover fully in the direction indicated "OPEN" using a coin or the like, and pick the cover up to remove it.
4. Pry up the battery using a flathead screwdriver or the like. While prying it up, lightly put a finger on the battery since it may pop out of the holder.
5. Replace the battery with a new one. Slide the battery under the plastic claw, and push it into the holder until it clicks.
6. Replace the battery cover, then turn it in the direction indicated "CLOSE" using a coin.

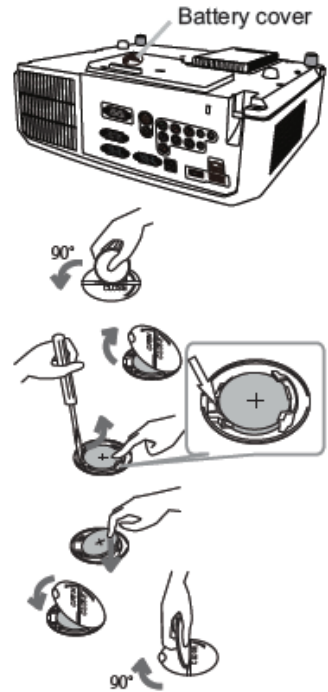

NOTE

- The internal clock will be initialized when the battery is removed.

WARNING

- Be careful handling a battery, as a battery may cause explosion, cracking or leakage, which may result in a fire, an injury and environment pollution.
- Only use the specified and perfect battery. Do not use a battery with damage, such as a scratch, a dent, rust or leakage.
- When replacing a battery, always replace it with a new one.
- If a battery leaks, wipe the leakage out with a waste cloth. If the leakage adheres to your body, immediately rinse it well with water. If a battery leaks in the battery holder, replace the batteries after wiping the leakage.
- Make sure the plus and minus terminals are correctly aligned when loading a battery.
- Do not work on a battery; for example recharging or soldering.
- Keep a battery in a dark, cool and dry place. Never expose a battery to a fire or water.
- Keep a battery away from children and pets. If swallowed, consult a physician immediately for emergency treatment.
- Obey the local laws on disposing a battery.

SPECIFICATIONS

Item	Specification	
Product name	Liquid crystal projector	
Liquid Crystal Panel	786,432 pixels (1024 horizontal x 768 vertical)	
Lamp	<CP-X2011N> 190 W UHP <CP-X2511N, CP-X3011N, CP-X4011N> 210 W UHP	
Speaker	16 W mono (8 W x 2)	
Power supply/Rated current	<CP-X2011N> AC 100-120 V/3.2 A, AC 220-240 V/1.7 A <CP-X2511N, CP-X3011N, CP-X4011N> AC 100-120 V/3.4 A, AC 220-240 V:310 W	
Power consumption	<CP-X2011N> AC 100-120 V: 310 W, AC 220-240 V:290 W <CP-X2511N, CP-X3011N, CP-X4011N> AC 100-120 V: 330 W, AC 220-240 V:310 W	
Temperature range	5 ~ 35°C (Operating)	
Size	317 (W) x 98 (H) x 288 (D) mm * Not including protruding parts. Please refer to the following figure:	
Weight (mass)	approx. 3.5 kg	
Ports	Computer input port COMPUTER IN1 D-sub 15 pin mini x1 COMPUTER IN2 D-sub 15 pin mini x1 Computer output port MONITOR OUT D-sub 15 pin mini x1 Video input port Y, Cb/Pb, Cr/Pr (Component video).....RCA x3 S-VIDEO.....mini DIN 4 pin x1 VIDEORCA x1	HDMI input port HDMI.....HDMI connector x1 Audio input/output port AUDIO IN1.....Stereo mini x1 AUDIO IN2.....Stereo mini x1 AUDIO IN3 (R, L).....RCA x2 AUDIO OUT (R, L).....RCA x2 Others USB TYPE A.....USB-Ax1 USB TYPE B.....USB-Bx1 CONTROL.....D-sub 9 pin x1 LAN.....RJ45 x1 MIC.....Stereo mini x1
Optional Parts	Lamp: DT01021 Filter set: MU06481 Mounting accessory: HAS-3010 (Bracket for ceiling mount) HAS-204L (Fixing adaptor for low ceilings) HAS-304H (Fixing adaptor for high ceilings) Laser remote control: RC-R008 Soft case: CA3010 *For more information, please consult Teq.	

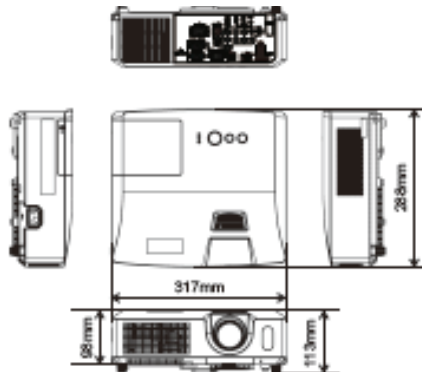

TROUBLESHOOTING - WARRANTY AND AFTER-SERVICE

If an abnormal operation (such as smoke, strange odor or excessive sound) should occur, stop using the projector immediately.

Otherwise, if a problem occurs with the projector, contact Teq.

NOTE

- The information in this manual is subject to change without notice.
- The manufacturer assumes no responsibility for any errors that may appear in this manual.
- The reproduction, transfer or copy of all or any part of this document is not permitted without express written consent.

Trademark acknowledgment

- Mac®, Macintosh® and Mac OS® are registered trademarks of Apple Inc.
- Pentium® is a registered trademark of Intel Corp.
- Adobe® and Acrobat®, Reader® are registered trademarks of Adobe Systems Incorporated.
- Microsoft®, Internet explorer®, Windows®, Windows NT® and Windows Vista® are registered trademarks of Microsoft Corporation in the U.S. and/or other countries.
- PowerPC® is a registered trademark of International Business Machines Corporation.
- HDMI, the HDMI logo and High-Definition Multimedia Interface are trademarks or registered trademarks of HDMI Licensing LLC in the United States and other countries.
- Blu-ray Disc™ and Blu-ray™ are trademarks of Blu-ray Disc Association.

All other trademarks are the properties of their respective owners.

End User License Agreement for the Projector Software

- Software in the projector consists of the plural number of independent software modules and there exist our copyright or/and third party copyrights for each of such software modules.